

High pressure blower type HD240



- Type:** Side channel blower
- Configuration:** In the standard version, the fan on the intake side has a stainless steel filter that can be used after cleaning with compressed air. When using a fine filter, the stainless steel filter be removed.
- Features:** The device is suitable for operation with frequency inverters for speed control. If desired, the device can be equipped with a thermistor (PTC), the signal can be evaluated with an optional trip device. The tech. Data remains unchanged.
- Operating temperature:** The operating temperature of the radial pressure may **NOT exceed 60 ° C**.
- Ambient temperature:** -20 ° C to +60 ° C 400VAC;
- Voltage:** Optional 1 x 230 V: 230 VAC Capacitor, 40 uF / V



Technical data

Item No.:		5100200 / on request
Voltage	VAC	230-400 / 265-460
Frequency	Hz	50 / 60
Motor power	KW	2,2 / 2,55
Current consumption	A	5,1
Volumetric current	m ³ / min	3,65 / 4,42
Pressure difference	Pa	27'000 / 26'000
Speed	rpm	2900 / 3'500
Noise pressure level	LpA (db)	68,8 / 70,8
Weight	kg	26,5
Intake opening	mm	Ø 60 (outside)
Exhaust opening	mm	Ø 60 (outside)
Dimensions	mm (LxBxH)	395 x 327 x 365
Type of protection		IP 54

Power curve

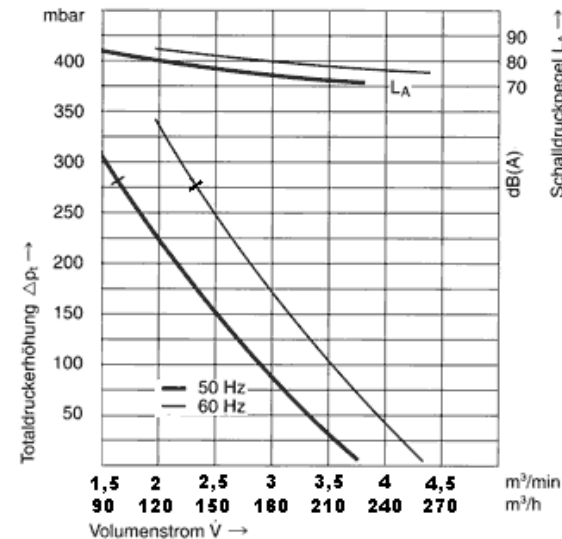











High pressure blower type HD240

Permissible vibration values according to ISO 14694

Fan application category [a _h]	Rigidly mounted [mm/s ²]	
	Peak	r.m.s.
BV-3	4,5	1,8

Accessories:

Item No. Description

5107278		Hose connection adaptor 1 x 60mm inside / 2 x 60mm outside
5107293		Hose connection adaptor 1 x 38mm inside / 2 x 38mm outside
5207293		Hose connection adaptor 1 x 38mm / 2 x 38mm – with thread outside
5107288		PVC air hose – Ø 60mm inside
5107285		Hose clip for hose Ø 60mm
5107240		Closure Cap for hose connection adaptor Ø 38mm
5107286		PVC air hose – Ø 60mm inside
5107287		Hose clip for hose Ø 38mm
5107241		Closure Cap for hose connection adaptor Ø 38mm
5110895		Stainless steel filter for HD240
5125908		Blowing-off nozzle I = 500mm; outlet opening adjustable; connector Ø 60mm outside; for air heater type L62 and high pressure blower type HD240
5125907		Blowing-off nozzle I = 300mm; outlet opening adjustable; connector Ø 60mm outside; for air heater type L62 and high pressure blower type HD240

High pressure blower type HD240

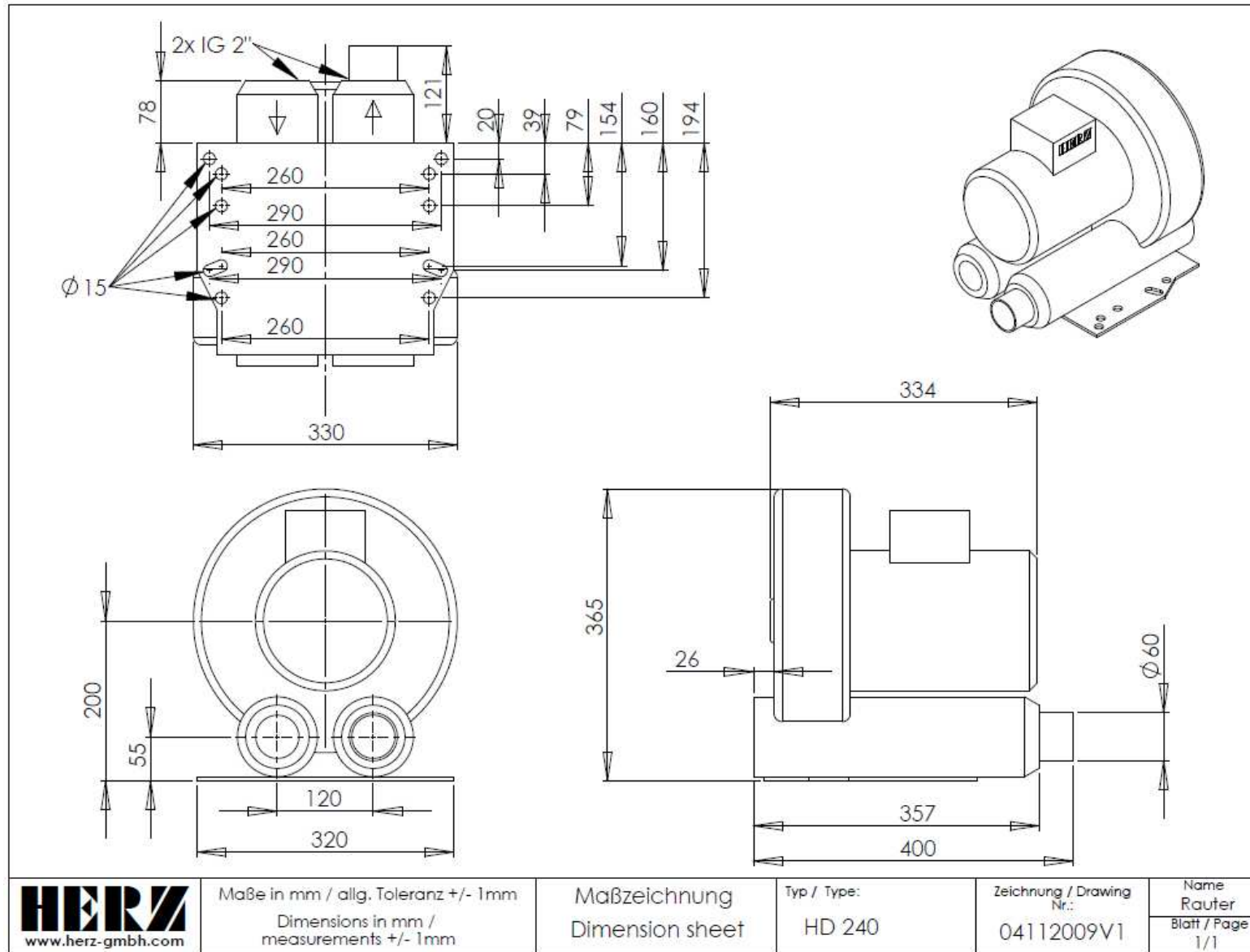

High pressure blower type HD240

HERZ GmbH

Kunststoff- & Wärmetechnologie
Biberweg 1

DE – 56566 Neuwied

Tel.: +49 (0)2622-81086; Fax: +49 (0)2622-81080

www.herz-gmbh.com; info@herz-gmbh.com

HERZ Austria GmbH

Kunststoff- & Wärmetechnologie

Gleinser Weg 27

AT – 6141 Schönberg / Tirol

Tel.: +43 (0)5225-63113; Fax: +43 (0)5225-6311385

www.herz-austria.at; herz.schoenberg@herz-gmbh.com

HERZ Hungária Kft.

Műanyag- es hőlégtéchnika

Pesti út 284. (HRSZ. 3335.)

HU – 2225 Üllő

Tel.: +36 (06)29-522400; Fax: +36 (06)29-522 410

www.herz-hungaria.hu; herz@herz-hungaria.hu

HERZ Bulgaria OOD

Boul. Assen Yordanov 10

BG – 1592 Sofia

Tel.: +359 (0)2-9790351; Fax: +359(0)2-9790793

www.herz-bulgaria.com; office@herz-bulgaria.com

HERZ GmbH

Kunststoff- & Wärmetechnologie
Am Arenberg 26A

DE – 86456 Gablingen

Tel.: +49 (0)8230-85085; Fax: +49 (0)8230-85087

www.herz-gmbh.com; robert.einberger@herz-gmbh.com

HERZ Austria GmbH

Kunststoff- & Wärmetechnologie

Johann-Galler-Str. 20 IZ – NÖ – Nord

AT – 2120 Wolkersdorf i. Weinviertel

Tel.: +43 (0)2245-82494-0; Fax: +43 (0)2245-82494-9

www.herz-austria.at; herz.wolkersdorf@herz-gmbh.com

HERZ Polska Sp.z o. o.

Technologie obróbki tworzyw sztucznych

Ul. Kostrzyńska 30

PL – 02-979 Warszawa

Tel.: +48 (0)22-8428583; Fax: +48 (0)22-8429700

www.herz.polska.pl; herz.polska@herz-gmbh.com

