

**Air heater type S32 from 1,55 to 2,0 KW**



- Function:** Air heater with external air supply by means of fan or compressed air.  
CAUTION !!! Device is not pressure-resistant !!!
- Configuration:** Default: Temperature control with potentiometer (1 – 8)  
 - alternatively with external potentiometer (cable length 5 meter) or  
 - external control by control unit or SPS (cable length 5 meter)  
 Device is equipped with a reliable heating element protection. The integrated device protection turns off the device when tripped and resets automatically after cooling down. A reset is not required.
- Features:** Special design with internal thermocouple (cable length 1 or 5 meter):  
 - for devices with electronic equipment max. supply air temperature 50°C  
 - the unit is available without electronics (without heating element protection)  
 - for devices without electronic equipment max. supply air temperature 80°C
- Power:** 1,55 KW, 2,0 KW  
**Voltage:** 230 VAC

**Technical Data:**

Item number	5101340 (5101336*)	5101355 (5101353*)	5101357 (5101359*)
Voltage	VAC	230	
Frequency	Hz	50 / 60	
Power	KW	1,0	2,0
Current	A	4,4	8,7
Max. temperature	°C	650	
Min. air volume	l/min	120 (150*)	260 (334*)
Weight	kg	0,4	
Air intake	Ø mm	19	
Air outlet	Ø mm	16	
Heater tube	Ø mm	32	
Dimensions	mm (L x W x H)	228 x 69,5 x 58	
Conformity mark			
Protection class II			

\*ohne Elektronik

Air heater type S32 from 1,55 to 2,0 KW

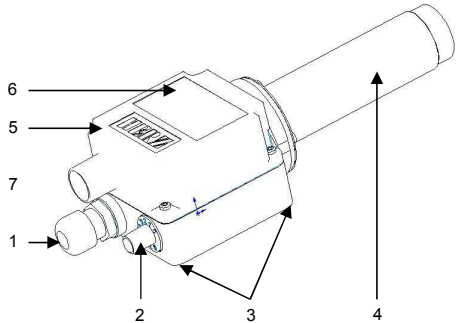
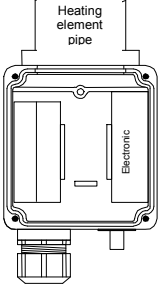
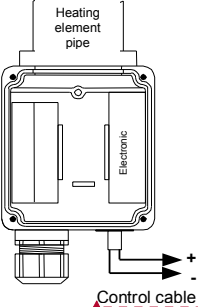
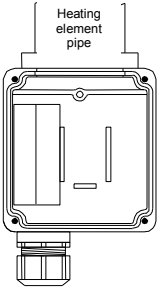
Product description:	Connection scheme:		
		<p><b>Default with potentiometer</b></p> <p>N, L1 = Main connection according to data plate</p>	 <p><b>External control</b></p> <p>N, L1 = Main connection according to data plate</p> <p>Digital signal (PWM max. 0,5Hz) 10-24VDC + = brown - = white</p>
<ol style="list-style-type: none"> <li>1. Cable fitting mains supply</li> <li>2. Potentiometer 0-8 (control cable für ext. control); (no Potentiometer for devices without electronic)</li> <li>3. Mounting on bottom of housing M 4 (screw depth 7 mm)</li> <li>4. Heatin element pipe Ø32mm</li> <li>5. Cover</li> <li>6. Data plate</li> <li>7. Air intake Ø19mm</li> </ol>		<p><b>Version without electronics</b></p> <p>N, L1 = Main connection according to data plate</p>	







Formatiert

### Air heater type S32 from 1,55 to 2,0 KW

**Available Versions:**

Item no.	Description
<b>5101340</b>	<b>Air heater S32 230 VAC 1,0 KW potentiometer</b>
5101337	Air heater S32 230 VAC 1,0 KW for external control with 5 meter control cable
5101338	Air heater S32 230 VAC 1,0 KW for external control with 5 meter control cable and internal thermocouple
<b>5101336</b>	<b>Air heater S32 230 VAC 1,0 KW ohne Elektronik</b>
5101339	Air heater S32 230 VAC 1,0 KW without electronic and internal thermocouple
<b>5101355</b>	<b>Air heater S32 230 VAC 1,5 KW Potentiometer</b>
5101356	Air heater S32 230 VAC 1,5 KW for external control with 5 meter control cable
5101360	Air heater S32 230 VAC 1,5 KW for external control with 5 meter control cable and internal thermocouple
<b>5101353</b>	<b>Air heater S32 230 VAC 1,5 KW ohne Elektronik</b>
5101361	Air heater S32 230 VAC 1,5 KW without electronic and internal thermocouple
<b>5101357</b>	<b>Air heater S32 230 VAC 2 KW Potentiometer</b>
5101358	Air heater S32 230 VAC 2 KW for external control with 5 meter control cable
5101362	Air heater S32 230 VAC 2 KW for external control with 5 meter control cable and internal thermocouple
<b>5101359</b>	<b>Air heater S32 230 VAC 2 KW ohne Elektronik</b>
5101363	Air heater S32 230 VAC 2 KW without electronic and internal thermocouple

**Accessories:**

Item no.	Description
5107283	 Flange connector. Push fit on the protective tube
5100303	 Tubular nozzle ø 5mm
5105475	  Wide slot nozzle 20 x 2mm
5105526	  Wide slot nozzle 40 x 2mm

## Air heater type S32 from 1,55 to 2,0 KW

**Combination possibilities for devices WITH electronic\*:**

**Measuring point:** 3.0 mm after the air outlet pipe adapter – without nozzle, measured at the hottest point  
**Hose length:** 1,0 m  
**Air supply:** Blower 400 Volt, 50 Hz (HD = High pressure blower, MD = Medium pressure blower)  
**Air flow:** NI / min = standard liters per minute according to DIN 1343

**CAUTION:** Air flow and temperature are indicative which can change due to external influences and changes air hose diameter and length!

Blower type	Quantity, air heater type, voltage, power	Air flow at 50 Hz with heating [NI / min.]	Maximum temperature at 50 Hz [°C]
HD140	1 x S32; 230VAC; 1,5KW	510	350
	2 x S32; 230VAC; 1,5KW	2 x 410	390
	4 x S32; 230VAC; 1,5KW	4 x 280	490
HD140	1 x S32; 230VAC; 2,0KW	470	450
	2 x S32; 230VAC; 2,0KW	2 x 390	470
HD 240	4 x S32; 230VAC; 2,0KW	4 x 530	320

\*Data without guarantee

Air heater type S32 from 1,55 to 2,0 KW

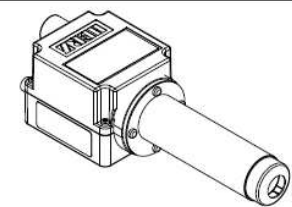
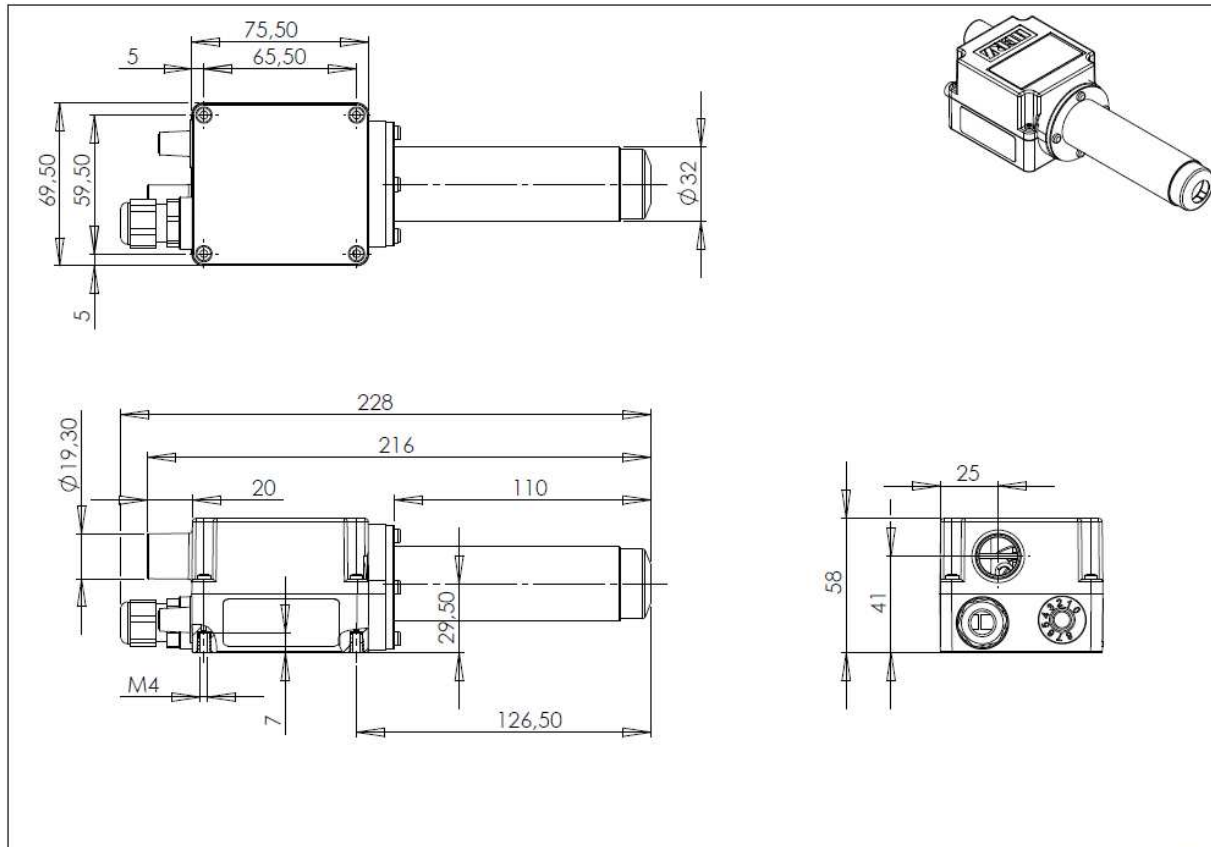

Maße in mm / allg. Toleranz +/- 1mm  
 Dimensions in mm /  
 measurements +/- 1mm

Maßzeichnung  
 Dimension sheet

Typ / Type:  
 S 32

Zeichnung / Drawing  
 Nr.:  
 08052008V1

Name  
 Hauser  
 Blatt / Page

Technische Änderungen vorbehalten / technical changes reserved

Air heater type S32 from 1,55 to 2,0 KW

**HERZ GmbH**

Kunststoff- & Wärmetechnologie  
Biberweg 1  
DE – 56566 Neuwied  
Tel.: +49 (0)2622-81086; Fax: +49 (0)2622-81080  
www.herz-gmbh.com; info@herz-gmbh.com

**HERZ Austria GmbH**

Kunststoff- & Wärmetechnologie  
Gleinser Weg 27  
AT – 6141 Schönberg / Tirol  
Tel.: +43 (0)5225-63113; Fax: +43 (0)5225-6311385  
www.herz-austria.at; herz.schoenberg@herz-gmbh.com

**HERZ Hungária Kft.**

Műanyag- és hőlégtéchnika  
Pesti út 284. (HRSZ. 3335.)  
HU – 2225 Üllő  
Tel.: +36 (06)29-522400; Fax: +36 (06)29-522 410  
www.herz-hungaria.hu; herz@herz-hungaria.hu

**HERZ Bulgaria OOD**

Boul. Assen Yordanov 10  
BG – 1592 Sofia  
Tel.: +359 (0)2-9790351; Fax: +359(0)2-9790793  
www.herz-bulgaria.com; office@herz-bulgaria.com

**HERZ GmbH**

Kunststoff- & Wärmetechnologie  
Am Arenberg 26A  
DE – 86456 Gablingen  
Tel.: +49 (0)8230-85085; Fax: +49 (0)8230-85087  
www.herz-gmbh.com; robert.einberger@herz-gmbh.com

**HERZ Austria GmbH**

Kunststoff- & Wärmetechnologie  
Johann-Galler-Str. 20 IZ – NÖ – Nord  
AT – 2120 Wolkersdorf i. Weinviertel  
Tel.: +43 (0)2245-82494-0; Fax: +43 (0)2245-82494-9  
www.herz-austria.at; herz.wolkersdorf@herz-gmbh.com

**HERZ Polska Sp.z o. o.**

Technologie obróbki tworzyw sztucznych  
Ul. Kostrzyńska 30  
PL – 02-979 Warszawa  
Tel.: +48 (0)22-8428583; Fax: +48 (0)22-8429700  
www.herz.polska.pl; herz.polska@herz-gmbh.com